

Power Industry AMI Thought Leadership

White Paper



NAVIGANT



contents

e.huawei.com

Power Industry AMI Thought Leadership

DISCLAIMER

This report was prepared by Navigant Consulting, Inc. (Navigant) for Huawei Technologies Co., Ltd. (Huawei). The work presented in this report represents Navigant's professional judgment based on the information available at the time this report was prepared. Navigant is not responsible for the reader's use of, or reliance upon, the report, nor any decisions based on the report. NAVIGANT MAKES NO REPRESENTATIONS OR WARRANTIES, EXPRESSED OR IMPLIED. Readers of the report are advised that they assume all liabilities incurred by them, or third parties, as a result of their reliance on the report, or the data, information, findings and opinions contained in the report.



04

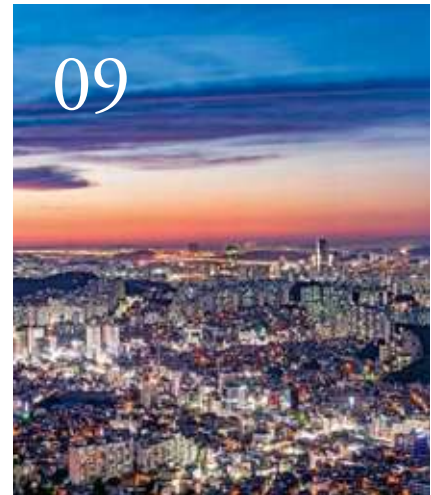

09

- 01** **AMI Introduction**
 - 01 Advanced Metering Infrastructure
- 04** **AMI TECHNOLOGIES**
 - 04 Hardware
 - 05 Software
 - 05 AMI Telecommunications
- 09** **AMI MARKET TRENDS**
 - 09 Drivers
 - 10 Barriers
- 11** **GLOBAL SURVEY OF THE AMI MARKET**
 - 11 Regional Trends
 - 12 Prospects for Smart Meter Adoption by Region
- 14** **MARKET FORECASTS**
 - 14 Smart Meter Shipments and Revenue
- 17** **CONCLUSION**



AMI INTRODUCTION

Advanced Metering Infrastructure

Advanced metering infrastructure (AMI) is defined as an integrated system of meters, communications networks, both wired and wireless, and data management technologies that support two-way communication. An AMI system also enables two-way communications with customer-side systems such as home area networks (HANs), connected thermostats, in-home displays, and energy management systems. The term AMI can be used synonymously with smart meters, or smart metering. While smart meter deployments may be slowing in North America, the drive for smart meter deployments is strong worldwide. The benefits of smart meters are starting to be realized, and their applications are evolving.

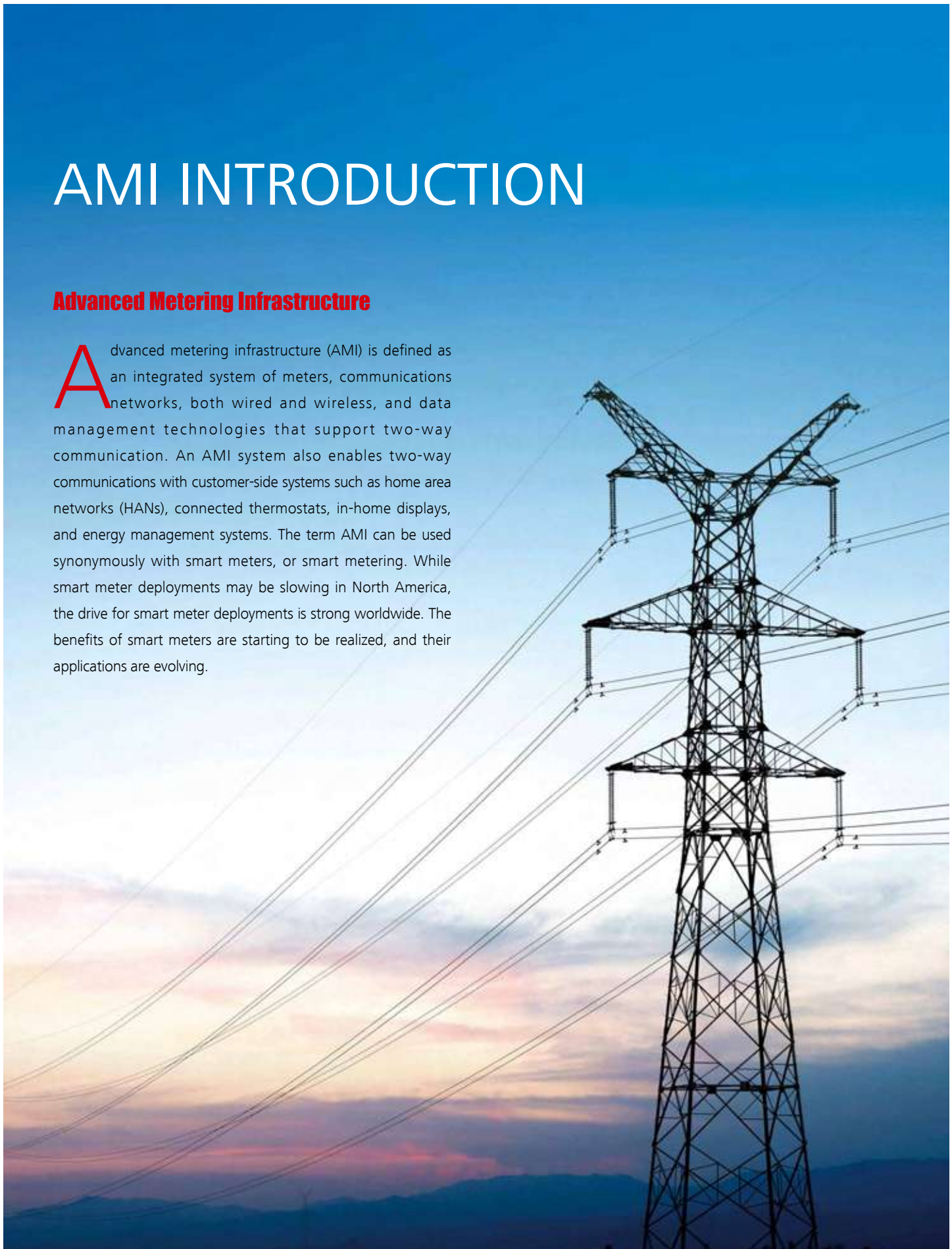

AMI-Smart Meter Market Maturing

The AMI—or smart meter—market is showing signs of maturing as utilities look for integrated solutions beyond just hardware, though the meters and related infrastructure are still crucial. Now that deployments are more plentiful, utility managers still in the planning or pilot phase have examples of how smart meter data can be utilized beyond billing and new rate structures. Utility managers recognize that interval meter data can tie into not only meter data management systems (MDMSs), but also other operational processes, including outage management systems, geographic information systems, and volt/volt-ampere reactive (Volt/VAR) control. The need for greater data analytics is a common theme, as well—how to make use of data in new ways that help make utility operations more efficient or enable greater customer engagement. As one vendor described the market, smart meters make it possible to use real-time (or near real-time) data to take action—something many utilities are just now starting to apply more frequently.

More Complex Billing Applications

When it comes to billing, the timelier and more accurate data emanating from smart meters eliminates the need to estimate consumption. This improves the accuracy of billing and enables more complex billing applications and rate structures, such as time-of-use (TOU) rates where customers are charged for energy depending on the time of day and the season the energy is used. For instance, a provincewide AMI deployment in Ontario, Canada means nearly all customers are on TOU billing. Smart meter data also allows for utilities to provide customers with more comprehensive billing information, such as kilowatt-hours of use and more detailed month-by-month cost comparisons.

Dynamic Pricing

As electricity customers grow familiar with accessing

and using timely information about their consumption through smart meters, utilities hope consumers will gain a better understanding of the dynamic nature of electricity costs. Because electricity cannot be stored easily, the wholesale price of electricity can vary substantially depending on supply-demand conditions and time of day. Utilities have created dynamic pricing schemes or tariffs for larger commercial and industrial (C&I) customers to more closely reflect the dynamic nature of wholesale electricity prices. With the proliferation of advanced meters that can record usage at small intervals, more dynamic types of pricing can now be applied down to the residential level. The ultimate solution is real-time pricing, which simply passes through the actual cost of electricity to the customer. More moderate versions include critical peak pricing or peak-time rebates, which charge higher prices or reward refunds, respectively, during a limited amount of peak hours throughout the year.

Demand Response

Smart meters and AMI can enable programs like demand response (DR), helping utilities operate more efficiently during peaks in demand. Metering for DR purposes can be fulfilled either through a customer's utility meter or through some manner of shadow or submetering. For residential DR, the utility meter is the main metering source. On the C&I side, some utility and regional transmission organization DR programs allow the utility meter to be the data collector on record, while others require additional, more granular meter data that necessitate additional equipment. Particularly with the expansion of AMI, hourly or subhourly data can be obtained in a timely method to meet the operational and settlement needs of a DR program.

Home Energy Management

There is a growing perception among consumers that connected devices—like thermostats, LED lighting, and smart meters—coupled with services can help them more efficiently manage the consumption of

electricity or other energy resources. The growing amount of AMI deployments not only provides consumers with data and information on their energy usage, which could motivate them to decrease their consumption, but also enables them to participate in energy efficiency programs. For example, some utilities have seen how linking smart meters with smart thermostats can enable residential DR and provide customers with a way to lower energy bills and help the utilities better manage peak loads.

Support for Other Technologies and Applications

AMI deployments are also key enablers for applications such as electric vehicle (EV) recharging and prepaid billing. AMI has supported EV adoption by allowing charging stations to integrate with TOU rates, which encourages off-peak charging. Additionally, AMI metering allows utilities to analyze charging station usage and charging behaviors based on TOU, which informs utility investment decisions related to EV

charging. Prepaid billing has been supported by smart metering, as well, as the meters keep track of energy consumption and can help consumers budget and better track their energy credit. For instance, U.K. utility E.ON is piloting its Smart Pay-As-You-Go prepaid option for customers with smart meters, with plans to expand it fully during 2016.

Data Analytics

Both prescriptive and predictive analytics have become an increasingly important and necessary part of the software systems supporting AMI deployments. The insight and knowledge that can be gained from data analytics not only help utilities take more informed actions and make better investment decisions, but also enable a range of applications, such as outage management, distribution management, DR, TOU rates, power quality monitoring, grid operations management, behind-the-meter distributed energy resources (DER) integration, and home energy management.





Hardware

At the center of an AMI deployment are the smart meters. These devices must meet certain requirements, irrespective of the integrated communications technology. Each region, country, or even specific utility will have its own set of required specifications. The basic requirements include the ability to accomplish a variety of tasks:

- Capture an onboard storage of granular interval data, usually two or more channels, providing the ability to read usage data at programmable intervals as low as 5 minutes and possibly over 1 hour. Smart meters usually can store at least 30 days (and some up to 1 year) of measurements at 15-minute intervals.
- Meet and be certified to standards of accuracy for measuring power consumption, excluding the power actually consumed by the meter itself.
- Meet environmental and reliability standards for installation in harsh outdoor environments where applicable.
- Support robust physical and communications security

standards.

- Support secure remote upgrades of onboard firmware, allowing additional features to be added without disrupting service; this requirement is particularly relevant in North America and Europe.
- Support submetering to colocated gas, water, or heat meters where necessary.

Internet of Things

One of the new developments related to the AMI market is the emerging and overlapping Internet of Things (IoT) trend. There are several hardware groups that can interact with or be influenced by a smart meter deployment. Besides the smart meters themselves, other customer products that influence energy consumption include smart thermostats, lighting networks, smart appliances, connected security and management systems, and smart plugs. When connected to an AMI system, these hardware devices provide the sensing and control capabilities for creating more energy efficient homes and commercial smart buildings. Navigant Research expects the AMI and IoT

trends to continue to overlap in coming years and be influenced by not only utilities, but also third-party vendors supplying hardware, software, and services.

Software

The increasing volume of meter data and new applications that rely on this data, such as demand-side management and grid optimization, have driven the need for data software such as meter data management systems (MDMSs). The term MDMS refers to a system of record that collects, processes, and stores meter data to help utilities turn that information into valuable insights that improve the operation of the grid. Data repositories for meter data, in some form or another, have been a part of the utility IT suite for years. However, after the widespread introduction of AMI, legacy MDMSs were unable to process the amount of interval data from smart meters and had to be replaced with solutions focused more on analytics, scalability, and flexibility. Today, MDMS vendors have seen more utility companies prioritizing a data architecture as a necessary implementation before deploying smart meters—whereas traditionally, it had been seen as an afterthought to smart meters.

AMI Telecommunications

Much of the benefit from smart meters depends on a communications network that links the devices and enables key data to flow in real-time or near real-time so that customers and utilities can respond accordingly and make efficient energy choices. This network is part of the AMI system. Numerous neighborhood area network (NAN) networking technology choices are available, both wired and wireless. In general, radio frequency (RF) or wireless mesh technologies prevail in North America, while power line communications (PLC) leads in Europe and is gaining in Asia Pacific—though there are exceptions as market dynamics continue to shift. In other regions, the choices are similar and will depend on regulatory factors, the specific needs of a utility, and prevailing metering technologies. As two-way communications between

utilities and consumers become more prominent, utility bandwidth and data security will be much more important and may require dependence on vendors with professional communications technologies. The differing technologies available on the market today are discussed below.

PLC

PLC provides connectivity using existing power lines as the communications medium. There are multiple types of systems (and terminologies) associated with PLC, and nearly as many standards. In addition, there are technologies aimed at in-building or in-home use, those aimed at external electrical plant use, and those that support both. External plant applications are considered here. PLC systems make up the vast majority of NAN systems in Europe and were the leading solution for early North American systems until the rapidly increasing popularity of RF systems. Additionally, some systems are targeted for use on the low-voltage (LV) portion of the grid (from transformer to the premises) and/or the medium-voltage (MV) portion of the grid (neighborhood regional distribution to local transformers). Figure 2-1 captures the layout of a typical PLC system.

Low-Speed PLC

Among the earliest PLC systems are ripple control systems—first introduced in the 1930s and still used

Figure 2-1. A PLC Topology

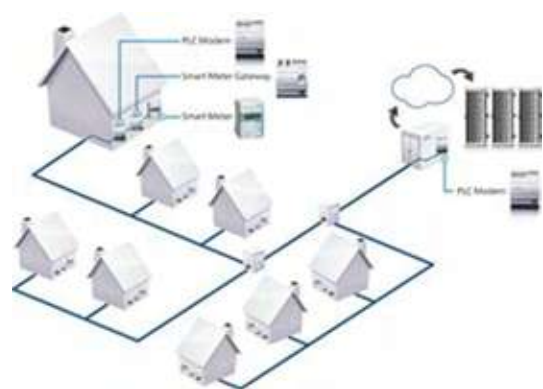

(Source: devolo AG)

in parts of Europe and New Zealand to provide basic low-bandwidth direct load-control and other telemetry. These use basic modulation schemes on a lower frequency carrier to convey information at a rate of 10 bps. Low-speed PLC systems have been widely deployed for remote meter reading and direct load-control applications. These systems are expected to continue to find success in specific niches. Examples of such niches include single-purpose metering applications in rural areas where the extended reach is valuable and emerging markets where basic meter reading and control are all that are required to support anti-theft initiatives.

Narrowband PLC

Narrowband PLC (N-PLC) systems generally use the Comité Européen de Normalisation Électrotechnique (CENELEC) bands defined by EN 50065, whether used in Europe or elsewhere. There are several different implementations with varying data rates, modulation schemes, and degrees of adherence to open standards.

G3-PLC was first proposed by Électricité Réseau Distribution France (ERDF), a French power distribution company. In September 2009, Maxim and Sagem Com released a jointly developed G3-PLC solution. In 2007, Iberdrola, a Spanish electric utility company, called for vendors of PLC chips, systems, and meters to establish a narrowband PLC AMR standard known as PowerLine Intelligent Metering Evolution (PRIME), as well as the PRIME Alliance based on the standard.

Due to the characteristics of PLC communication channels, the narrowband PLC technology has disadvantages or defects in terms of impedance, anti-noise, and bandwidth.

1. Impedance: The narrowband PLC works in frequency bands lower than 1 MHz, causing low impedance that impairs PLC signal transmission. It requires greater transmit power to achieve the same communication distance. However, line drivers (LDs) provide low efficiency of power amplification.
2. Anti-noise: low-frequency noise is greater than high-

frequency noise. Therefore, PLC communication working in frequency bands lower than 1 MHz is susceptible to greater noise.

3. Bandwidth: Due to the limited number of subcarriers, frequency band self-adaption for data backup is impossible. As the communication frame is too long, the narrowband PLC cannot cope with rapid changes in communication channels or impulsive noise interference, among other problems. In addition, the low communication rate cannot meet the demand for multi-meter rapid networking and response to short meter reading cycle.

Broadband over Power Line

Broadband over power line (BPL) systems generally refer to PLC systems supporting data rates over 1 Mbps. An example of this type of solution is Huawei's PLC-IoT, which allows for more transformers, real-time monitoring, remote upgrades, and remote measuring and controls. Like N-PLC, there is no shortage of BPL systems and proposals, and there is a long-running standards war over BPL technology for in-home use.

PLC-IoT accurately and effectively establishes a power line communication channel-based transmission model that determines the optimal signal transmission frequencies based on frequency characteristics. In addition, Huawei analyzed the features of power line channels based on massive amounts of data collected from grids. The characteristics include attenuation, impedance, and noise. Consequently, Huawei succeeded in developing unique anti-noise and anti-attenuation technologies that greatly improves power line communication performance, implementing high-speed, reliable, real-time, and long-distance communication over power line carriers.

BPL is an important technology for AMI meter reading communications, as most BPL services intended for use by utilities are positioned as future-proof. BPL can provide adequate bandwidth to run not only current applications, but also future ones, such as home energy management and control applications, distributed generation

management tools, and management of EVs. It should also be noted that the increased security controls required of advanced networks will simply take up too much bandwidth on an N-PLC system. Thus, a fatter pipe will be needed to adequately secure the utility communications network down to the meter level. Huawei, one vendor active in the BPL space, has developed what it calls a Huawei PLC-IoT solution. This solution provides bidirectional, real-time, and high-speed communications over power lines with improved performance over narrowband systems. Compared to wireless solutions, this offering does not require additional devices or RF antennas, which can be important to utilities seeking to avoid customer complaints while also improving the communications rate.

RF Mesh

RF-based mesh networks continue to be the leading NAN technology for deployments in North America. A mesh network forms a web-like network topology as illustrated in Figure 2-2. Any node not in direct communications range of its target destination (such as a meter sending data to a concentrator) will have its data relayed by another node in the mesh (e.g., another meter). A given data packet between a source and destination node may hop through many intervening nodes. Hence, the effective range of the network is extended well beyond the range of any single transmitter or receiver. Effective mesh networks are self-configuring and self-healing. They automatically determine which nodes are in range and reconfigure when the topology changes, such as when a node is added or removed or an obstacle between two nodes is added or removed.

RF Point-to-Multipoint

RF point-to-multipoint (P2MP) systems use licensed radio spectrum allocations with greater allowed transmit power levels to enable communications between a centralized tower-based node and many meters (and other nodes) within the range of that tower. Wireless cellular phone infrastructure represents

a public RF P2MP network, where each cell represents the range of a given tower area and multiple towers provide overlapping coverage. There are also private RF P2MP NAN implementations, where tower-based gateways provide overlapping (though not necessarily mobile) coverage to all meters within range. This is referred to as a star topology, where each node is within direct range of the center of a star (gateway).

Cellular

One of the more familiar RF P2MP systems is the public cellular infrastructure. Smart meters with integrated cellular modems are in widespread use for C&I meter systems, where the expense can be justified. However, there are a number of obstacles to the use of public cellular infrastructure for residential NAN applications. Most of these, though, derive from a historic lack of a compelling business offering by wireless carriers, particularly in North America, where carriers tended to treat meters like consumer cell phones. Using the typical mobile wireless subscriber business model, therefore, yields high per-node operating costs compared to the operation of private networks. Cellular wireless is commonly used for wide area network (WAN) connectivity to the various NAN concentrator technologies, where the individual node cost is

Figure 2-2. Mesh Network Configuration

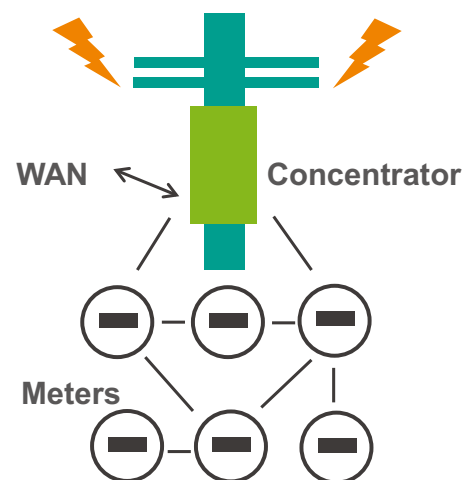

(Source: Navigant Research)

Figure 2-3. Star Network

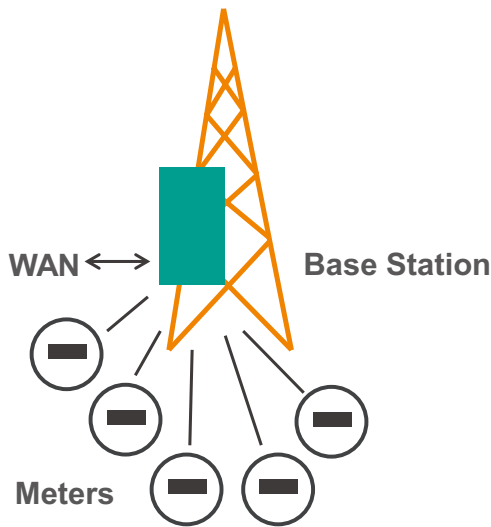

(Source: Navigant Research)

amortized over hundreds or thousands of meter nodes.

Another two emerging solutions in this space, are the use of WiMAX or eLTE-IoT (and emerging 4G

technologies) for NAN applications. As modem costs decline and public operators offer cost-attractive and secure virtual private networks enabled by the technology, this option could become quite appealing to utilities, especially given the possible greater than 1 Mbps performance options.

HAN/NAN/WAN

A typical AMI system includes various components:

- A NAN, which connects each smart meter within a local neighborhood and ultimately linking to a utility’s IT infrastructure.
- A WAN, the communications backbone that links meter data concentrators to the utility’s headend systems.
- A HAN, which connects devices in the home—such as displays, thermostats, load-control devices, and smart appliances—to the overall smart metering system. The HAN may also connect other meters—such as gas and water—to the NAN.

Figure 2-3. Star Network

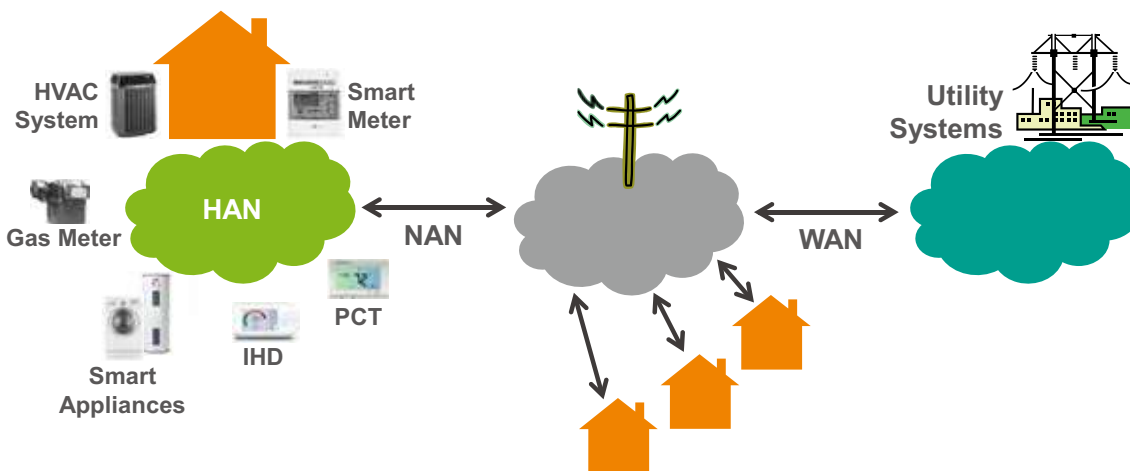

(Source: Navigant Research)



AMI MARKET TRENDS

Drivers

In many regions, regulatory policies are the major force driving smart meter deployments. Policymakers view smart meters as a key technology to help reach goals related to climate change or increased energy security, since smart meters enable greater energy efficiency and better peak demand shifting.

In the United States, the federal government implemented policy to further motivate the deployment of smart meters nationwide. The Obama administration’s American Recovery and Reinvestment Act (ARRA) targeted approximately \$3.4 billion dollars of stimulus funds toward accelerating smart grid technology deployments and green jobs associated with these deployments. Most ARRA-funded projects have since been completed, and smart meter deployments are expected to slow down with the lack of additional policy and funding.

The European Union (EU) has issued the most far-reaching regulatory policies as a region, with conservation

and energy efficiency the main goals. The EU’s 20-20-20 initiative set three targets for member countries: to reduce greenhouse gas emissions by 20%, improve energy efficiency by 20%, and increase the percentage of renewable energy by 20%, all to be realized by 2020. As part of implementing the 20-20-20 initiative, the European Commission’s Third Energy Package says member states must assess the need for smart meters, and Directive 2009/72/EC states that “Member States shall ensure the implementation of intelligent metering systems that shall assist the active participation of consumers in the electricity supply market.” However, a clause allows member states to conduct a cost-benefit analysis of smart meters; if results are negative or mixed, the member state can refrain from mandating a full rollout.

Governments in Asia Pacific have identified energy efficiency as a critical component in their approach to tackling climate change. The first smart meter activities in Asia Pacific began in Australia, where the State of Victoria mandated the deployment of advanced smart meters. The rest of the Asia Pacific market has been characterized

by rapid and dramatic changes. In particular, in 2009, China announced a 10-year smart grid initiative that includes the large-scale deployment of smart meters totaling 300 million. Japanese energy policy has taken a turn in the wake of the 2011 Fukushima Daiichi disaster; while nuclear will remain in the energy mix, policy is focused on demand management and new technologies like smart meters. India is looking at smart meter deployments as a way to prevent the theft and illegal usage of electricity, and the Restructured Accelerated Power Development and Reforms Programme in India has initiated the path for substation-level automation and overall smart grid practices, including metering solutions.

Besides clear regulatory mandates, the key business drivers for smart meter deployments have not changed as the market matures. The predominant reasons for utilities to deploy smart meters are largely operational:

- **Reduced labor costs:** By not having to dispatch staff regularly to record meter consumption data or connect or disconnect service, operating costs decrease.
- **Improved operations and reliability:** Two-way communications with meters enable more accurate outage detection and swifter service restoration.
- **Improved billing accuracy:** By eliminating estimated consumption, the amount for billing is more exact.
- **Reduction in or prevention of theft of service:**



Smart meters can detect and record theft of electrical service, which can amount to 20% or more of total energy supply in some markets.

- **Increased energy efficiency and peak demand reductions:** Smart meters enable programs like DR, which can help a utility more efficiently operate during peaks in demand.
- **Improved load management:** Based on smart meter trending analysis, utility operators get greater insight into electricity demand, which helps to determine the right amount of new transformer investments.
- **Increased customer engagement:** Customers are provided with timely data regarding consumption and costs and are therefore able to make more informed decisions about usage and generally be more involved.

Barriers

Even though momentum is building for smart metering, there are barriers that will keep growth in check:

- **Lack of a clear cost-benefit analysis:** For example, in Germany, a study concluded that a mandated national rollout was not warranted. A selective approach will be used instead.
- **High deployment cost:** A wide-scale rollout involves significant investments; for countries or utilities lacking resources or not wanting to burden customers with higher tariffs, the financial hurdle is likely to hinder projects.
- **Lack of regulatory support:** In some locations, there is no legal framework or favorable policy for deployments.
- **Technology challenges:** With multiple standards for meters and communications protocols available, devices can be incompatible across vendors.
- **Skills shortage:** Some utilities, especially midsize and smaller ones, may not have sufficient in-house competencies to support a deployment or the ongoing operations of an AMI system.
- **Pushback from consumers:** Vocal customers have raised privacy and health concerns related to smart meters, and some regulators have mandated opt-out programs to placate those concerns.



GLOBAL SURVEY OF THE AMI MARKET

Regional Trends

The smart electric meter market has shifted to a new phase in which the emphasis is on projects coming together in various countries in Europe and Asia Pacific. In North America, the frenzy of new deployments is over. Global and regional smart meter vendors point to business activity picking up in Europe, where utilities in Spain, France, and the United Kingdom have projects underway, with conservation and energy efficiency as the main goals. In Asia Pacific, utilities in Japan, China, and India are expected to have major smart meter deployments over the next decade due to energy efficiency playing a key role in their approach to tackling climate change. In Latin America, Mexico leads the AMI market with 30.2 million smart meter installments expected by 2025. The country's motivation stems from high rates of electricity losses,

sometimes reaching over 20%. The Middle East and Africa have similar electricity loss issues to those in Latin America, and smart meter deployments are anticipated to pick up as these regions attempt to aim for greater electric grid efficiency and reduce technical and nontechnical losses.

Case Study

A recent case study from Nigeria provides an example of where AMI can increase meter data accuracy, reducing theft of service and boosting utility revenue. Electric utilities in Nigeria are challenged by the inability to collect accurate consumption data from a vast majority of customers, sometimes more than 80%, severely limiting profits and the ability to upgrade the grid. Some of these Nigerian utilities have turned to Huawei, a Chinese technology supplier that has developed a variety

of solutions to meet this critical challenge. These utilities are in the process of deploying Huawei's automatic metering system to some 400,000 residential customers. The new meters will be supported by a high-speed data network, including sensors and controllers that leverage a Huawei-developed PLC chip that supports 2 Mbps data communications. In addition, the system features a Huawei-designed IoT platform that integrates sensors, meters, and control systems. Data from customers' meters will be transmitted to local utilities once every 15 minutes, giving a near real-time view of usage within the network. With this AMI system in place, utilities can expect to greatly increase revenue and profit.

Prospects for Smart Meter Adoption by Region

Asia Pacific

In Asia Pacific, the volume of smart meter deployments over the past few years has continued to be strong, driven by the Chinese market. Utilities in other markets, such as the Philippines, Thailand, and Singapore, are mainly conducting pilots, but large-scale deployments appear to be a couple of years away.

For example, to date the State Grid Corporation of China (SGCC) has issued bids for a total number of 477 million smart meters. In two years alone from 2014 to 2015, the SGCC issued bids for more than 92 million sets of smart meters. It is estimated that from 2016 to 2020 approximately 460 million sets of new smart meters will be required in China. Till then, the country will boast the largest scale of smart meter application in the world.

In Japan, the rollout schedule of smart meters appears to be accelerating. The leading 10 utilities have announced plans to finish installing residential smart meters sooner than originally planned. The move was prompted by a need on the part of the incumbent utility monopolies to better prepare for expected competition once the retail sale of electricity is deregulated in 2016. Tokyo Electric Power Company (TEPCO) is projected to be the first to complete its

deployment under the revised schedule, installing about 27 million smart meters by the end of its fiscal year 2020. Six of the seven remaining utilities intend to complete smart metering projects in fiscal 2022 and 2023, with the seventh, Okinawa Electric Power Company, moving up its expected completion date to 2024 from 2032. By 2024, virtually all of Japan's roughly 80 million residential customers are expected to have a smart meter installed in their homes.

In China, deployments of smart meters and other smart grid assets keep moving at a rapid pace. State Grid Corporation of China (SGCC), which provides electricity to about 88% of the country, had deployed more than 210 million smart meters as of the end of 2014. The company expects to spend about \$240 billion between 2016 and 2020 on completing its smart grid project.

From 2013 to 2015, Huawei has deployed PLC-IoT modules in more than 1 million meters, covering 27 provinces and more than 100 areas in China.

India is just beginning its move toward smart metering, though officials have been making plans for several years. The country's Central Electricity Authority has developed specifications for smart meters, and 14 pilot projects are scheduled to take place through 2017. By then, about 1.5 million smart meters should be installed. Results from testing will be used to implement an aggressive rollout, which is expected to reach 150 million smart meters by 2027.

Latin America

Latin America continues to attract attention for its potential as a smart meter growth market, but so far, deployments have been more strategic than widespread. In Brazil, for instance, the market has been hampered since the national regulator's decision in 2012 to make smart meters optional. In the run up to the 2014 World Cup, there were expectations of more deployments, but the numbers were relatively minimal. For example, AES Eletropaulo has been piloting smart meters as a way to reduce theft of

service, but has not announced any large meter rollouts. Similarly, CPFL Energia has a pilot project involving about 20,000 smart meters but has not announced further activity. Other markets, such as Chile and Argentina, have pilot projects in place and have conducted targeted rollouts, but no recent announcements of new business have been made.

One shining light for smart meter deployments in Latin America is Mexico. Recently, Mexico announced that it will deploy 30.2 million smart meters by 2025. The country has already kick-started investments in the smart grid by issuing tenders for more than 2 million smart meters as part of the PIDIREGAS program. Mexico is expected to spend approximately \$10.9 billion on smart grid infrastructure across a number of market segments, including smart metering, distribution automation, battery storage, home energy management, information technology, and wide area measurement. The country's single state-owned utility, Comisión Federal de Electricidad (CFE), is looking into smart metering as a way to curb nontechnical losses and increase operational efficiency, as electricity losses in Mexico can reach over 20% in some regions.

Middle East & Africa

Smart metering has increased somewhat in the Middle East. A project in Lebanon, involving 1.2 million meters, would be the largest so far in the region. A similar

volume of meters is anticipated in the United Arab Emirates, where Dubai Electricity and Water Authority has announced the installation of about 120,000 meters at this point. The utility expects to deploy 1 million smart meters by 2020, with an investment of approximately \$2 billion during that period. In other markets, utilities are in the planning phase or have pilot projects in place. For example, Israel Electric Corp. is evaluating a pilot project involving 4,400 smart meters in Binyamina-Giv'at Ada.

In Africa, most of the metering projects are smaller or are in pilot phases. The City of Johannesburg in South Africa is in the process of deploying about 50,000 smart meters as part of a project. Meanwhile, Eskom, South Africa's national utility, has been developing a pilot project involving meters. In Nigeria, Huawei provides an end-to-end AMI solution that includes 300,000 installed meters, 8000 data collection units (DCUs), PLC-IoT as the main communications method, and its Standard Transfer Specification (STS) prepayment system for debt management. This solution reduced Nigeria's line loss from 45% to 14% over 6 months of the project. In Zimbabwe, the government intends to continue with plans to roll out smart meters, even though there has been controversy surrounding the deployment plan because of the expense. Navigant Research believes smart metering will slowly take hold in Africa in the coming decade, but projects are likely to be smaller in size compared to other regions because of funding issues and uneven regulatory guidance.



MARKET FORECASTS

Smart Meter Shipments and Revenue

Electric meter shipments of all types, not just smart versions, have grown worldwide in recent years because of abnormal growth patterns due to increased volumes of smart meter deployments and increased electrification. In the past, meters were replaced about every 20 years. However, North America, Europe, and China have been

experiencing disruptive replacement cycles as large-volume smart meter deployments change the norm. As a result, a lull in overall electric meter shipments (smart and non-smart versions) regionally began in 2015 and is expected to continue until 2017, with growth expected to recover between 2018 and 2020. The drop-off in 2017 reflects the eventual easing in Chinese shipments, which have been in a hyper-growth period since 2010.

Figure 5-1. Electric Meter Unit Shipments by Region, World Markets: 2013-2023

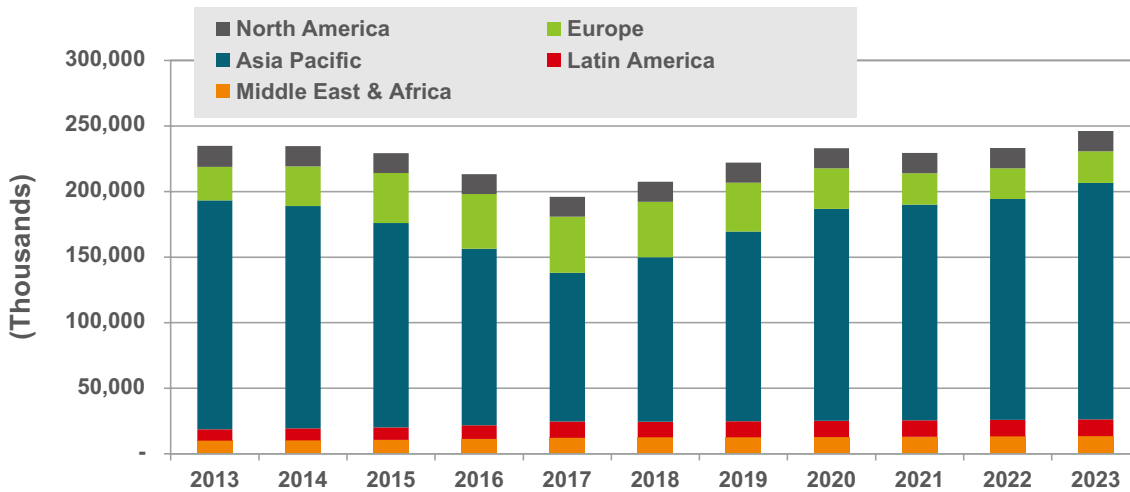

(Source: Navigant Research)

In terms of smart meters, the global market will experience overall growth during the forecast period. However, a trough is coming in 2017 for Asia Pacific as Chinese deployments slow and before the full impact of Japanese and, later, Indian deployments take hold. European smart meter deployments started growing in 2015 as countries joined in the effort to meet the EU target of 80% smart meter penetration by 2020. In North America, shipments will remain steady in the absence of new federal funding and

strong policy mandates.

Growth during the decade is expected to be spurred by China and India and supported by Latin American countries like Brazil, Mexico, and Chile. The latter countries are expected to deploy meters to modernize the grid and quell theft of service. Navigant Research expects global smart meter shipments to reach over 116 million by 2023, with a 2013-2023 compound annual growth rate (CAGR) of 3.0% due to the vary levels of deployment by region.

Figure 5-2. Smart Meter Unit Shipments by Region, World Markets: 2013-2023

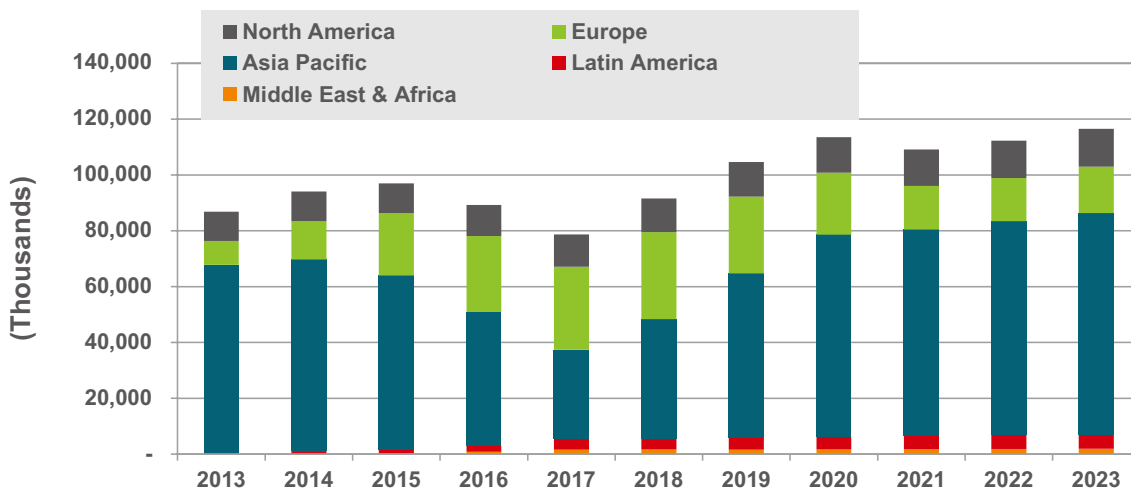

(Source: Navigant Research)

Asia Pacific

Annual smart meter revenue in Asia Pacific is anticipated to increase from \$2.4 billion at the outset of the forecast to \$3.8 billion in 2023, with a CAGR of 4.8%. However, note that a revenue trough is expected in 2017. The massive deployment in China is projected to eventually taper off and deployments in Japan and India will not yet have reached higher levels.

Figure 5-3. Smart Meter Revenue and ASPs, Asia Pacific: 2013-2023

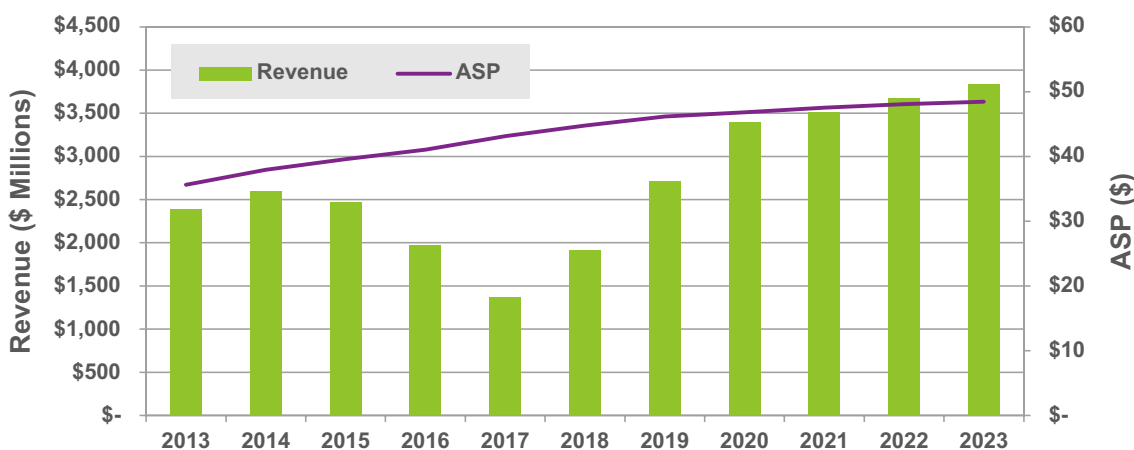

(Source: Navigant Research)

Latin America

Total revenue from smart meter shipments in Latin America is anticipated to increase from \$45.5 million at the beginning of the forecast to \$389.2 million in 2023 at a CAGR of 23.9%.

Figure 5-4. Smart Meter Revenue and ASPs, Latin America: 2013-2023

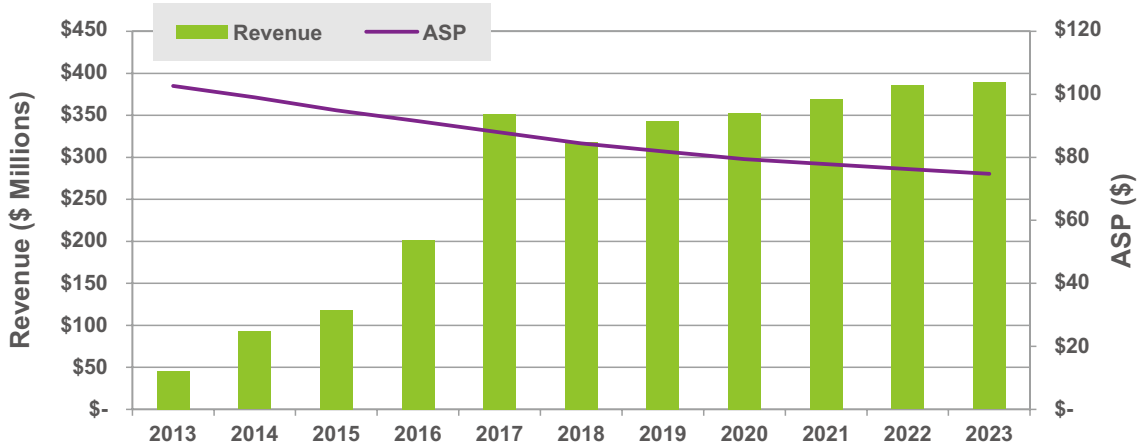

(Source: Navigant Research)

Middle East & Africa

Revenue from smart meter shipments in the region is projected to increase from \$16.7 million in 2013 to \$147.6 million in 2023 at a CAGR of 24.3%.

Figure 5-5. Smart Meter Revenue and ASPs, Middle East & Africa: 2013-2023

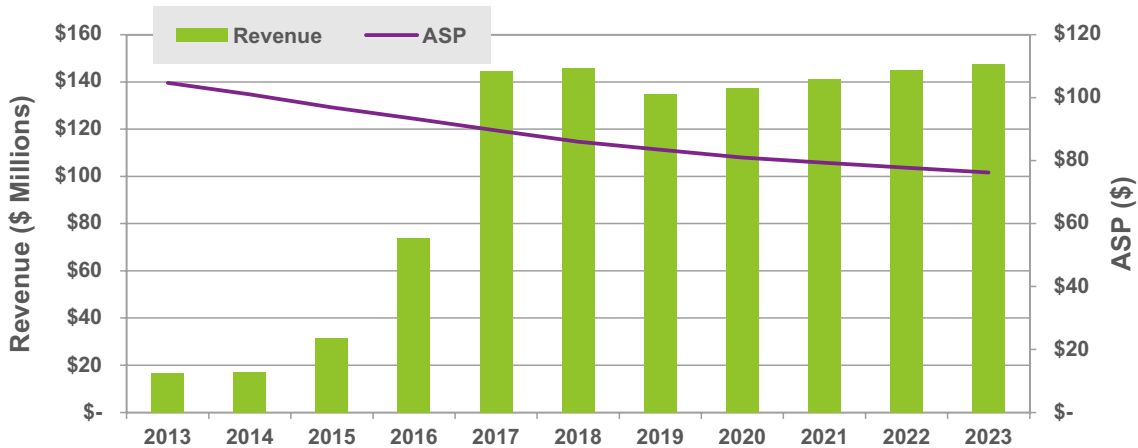

(Source: Navigant Research)



The pace of future smart meter deployments will vary by region and utility. The Western European and Asia Pacific markets represent healthy growth potential, both in the installation of new smart meters and upgrades to existing smart meter technologies. Growth in Europe is largely due to the EU's smart metering policy, which calls for 80% of households to have smart meters installed by 2020. In Asia Pacific, China is likely to continue to see substantial growth due to the relative ease with which SGCC, the overwhelmingly leading utility, can roll out waves of increasingly advanced meters. Similarly, in Japan, the smart metering boom is just beginning, with tens of millions of endpoints expected to be installed during this decade.

The adoption of AMI systems by utilities is part of a

long-term transformation to create a more intelligent grid. While the rate of adoption is expected to vary by region, advanced meters are projected to become the norm in time for several reasons:

- They provide grid managers with granular data and control capabilities that support greater system efficiency.
- They will be vital in a future of increased DER (e.g., rooftop solar), growing numbers of EVs, and new energy storage options. Older meters, cash registers essentially, were never designed for a grid as dynamic as the one now unfolding.
- Smart meters enable customers to become more efficient energy users, an important goal for consumers looking to reduce costs and regulators seeking equitable rates.

Copyright © Huawei Technologies Co., Ltd. 2017. All rights reserved.

No part of this document may be reproduced or transmitted in any form or by any means without prior written consent of Huawei Technologies Co., Ltd.

Trademark Notice



HUAWEI, and  are trademarks or registered trademarks of Huawei Technologies Co., Ltd.

Other trademarks, product, service and company names mentioned are the property of their respective owners.

General Disclaimer

The information in this document may contain predictive statements including, without limitation, statements regarding the future financial and operating results, future product portfolio, new technology, etc. There are a number of factors that could cause actual results and developments to differ materially from those expressed or implied in the predictive statements. Therefore, such information is provided for reference purpose only and constitutes neither an offer nor an acceptance. Huawei may change the information at any time without notice.

HUAWEI TECHNOLOGIES CO., LTD.

Huawei Industrial Base

Bantian Longgang

Shenzhen 518129, P.R. China

Tel: +86-755-28780808

Version No.: M3-036894-20170410-C-1.0

e.huawei.com